

INSTRUCTION MANUAL

HITACHI
Inspire the Next

42" Colour TV

42HXT12U

147/4680



DVB-T2

HDMI
HIGH-DEFINITION MULTIMEDIA INTERFACE

FULL HD 1080

Freeview HD

Important - Please read these instructions fully before installing or operating and keep for future reference.

These instructions contain important information which will help you get the best from your television and ensure safe and correct installation and operation.

For any help concerning set up and use of your TV please call the Customer Helpline: 0845 604 0105

Lines open: 9am - 8pm Monday to Saturday and 10am - 4pm Sunday

Contents

Safety Information	2	Configuring Network Settings	19
Preparation	2	Configuring Wired Device Settings	19
Intended Use	2	Network Type	19
Power source	3	Configuration Status	20
Positioning the TV	3	IP Address	20
Power cord and plug	3	Configuring Wired Network Settings in Advanced Mode	20
Moisture and Water	3	Configuring Wireless Device Settings (Optional)	20
Ventilation	3	Information	20
Heat sources and Flames	4	Connecting to your Cell Phone via WiFi (Optional)	21
Headphone Volume	4	Connectivity Troubleshooting	21
Wall Mounting (optional)	4	Wireless Network Not Available	21
LCD Screen	4	Connection is Slow	21
Cleaning	4	Distruption during playback or slow reactions	21
Batteries	4	Using DLNA Network Service	21
Replacement Parts	4	Step 1: Nero Media Home Installation	21
Taking out of service and storing	4	Step 2: Connect to a Wired or Wireless Network	21
Connection to a Television Distribution System (Cable TV etc.) from Tuner	4	Step 3: Play Shared Files via Media Browser	21
Symbols in this Instruction Book	5	Internet Portal	22
Getting Started	6	iPlayer Application	23
Support	6	Teletext	23
Environmental Information	7	Digital Teletext (for UK only)	23
Accessories included	7	Software Upgrade	23
Optional Accessories	7	Troubleshooting & Tips	23
TV - Features	7	Image persistence - ghosting	23
Viewing the TV	8	No power	23
TV Control button & Operation	8	Poor picture	23
Viewing remote control - TV	9	No picture	24
Using a Conditional Access Module	11	No sound	24
Standby Notifications	11	Remote control - does not operate	24
Installing the Batteries to the Remote	12	Input sources - can not be selected	24
Connect Power	12	Internet Connection Not Available / DLNA Mode Not Operating	24
Antenna Connection	12	Invalid Domain	24
Switching On/Off	12	DVB-T functionality information	24
To Switch the TV On	12	To Program Your SKY Remote For Your TV	24
To Switch the TV Off	12	PC Typical Display Modes	25
First Time Installation	12	Specifications	26
Aerial Installation	13	Licence Notifications	26
Media Playback via USB Input	13	Disposal information	26
Media Browser Menu	13	Supported File Formats for USB Media Browser	27
Using MENU button in Media Browser Mode	14	Supported DVI Resolutions	28
Changing Image Size: Picture Formats	14	Appendix: Nero MediaHome Installation	29
Using the Channel List	14	Getting Started with Skype	32
Sorting Channel List	14	Sign In & Sign Up Now	33
Quick Menu	14	Adding a contact	34
Menu Features and Functions	15	Recent history	34
Menu Features and Functions	16	Actions	35
Menu Features and Functions	17	Incoming call	36
Electronic Programme Guide (EPG)	18	Dialing Phones	36
Connectivity Functions	18	Settings	36
Connecting to a Wired Network	18	Guarantee	37
Connecting to a Wireless Network	19		

Safety Information

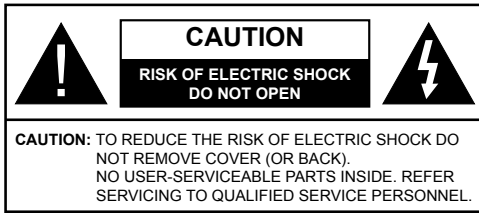

The lightning flash with arrowhead symbol, within an equilateral triangle, is intended to alert the user to the presence of uninsulated "dangerous voltage" within the product's enclosure that may be of sufficient magnitude to constitute a risk of electric shock of persons.

The exclamation point within an equilateral triangle is intended to alert the user to the presence of important operating and maintenance (servicing) instructions in the literature accompanying the appliance.

Don't operate your TV in extreme ambient conditions as this may cause damage to your TV..

Note : Follow the on screen instructions for operating the related features.

IMPORTANT - Please read these instructions fully before installing or operating

Preparation

Place the device on a solid even surface. For ventilation, leave a free space of at least 10 cm all around the set. To prevent any fault and unsafe situations, do not place any objects on top of the set. Use this device in moderate climates.

Operation temperature and operation humidity: 0°C up to 40°C, 85% rel. humidity max. (not blocking ventilation openings).

Intended Use

This device is used to receive and display TV programmes. The different connection options make an additional expansion of the reception and display sources possible (various external devices). This device is only suitable for dry interior use. This appliance is intended solely for private domestic use and may not be used for industrial and commercial purposes. We exclude liability in principle, if the device is not used as intended, or unauthorized modifications have been made. To operate your TV in extreme ambient conditions may cause the damage of the device.

This appliance is not intended for use by persons (including children) with reduced physical, sensory or mental capabilities, or lack of experience and knowledge, unless they have been given supervision or instructions concerning use of the appliance by a person responsible for their safety. Children should be supervised to ensure that they do not play with the appliance.

Children may not recognize dangers. The swallowing of batteries can be fatal. Keep batteries always out of reach of small children. If a battery is swallowed, seek immediate medical attention. Keep the packaging films out of reach of children, there is a risk of suffocation.

Please read the following recommended safety precautions carefully for your safety.

SOME DOS AND DON'TS ON THE SAFE USE OF EQUIPMENT

This equipment has been designed and manufactured to meet international safety standards but, like any electrical equipment, care must be taken if you are to obtain the best results and safety is to be assured.

DO read the operating instructions before you attempt to use the equipment.

DO ensure that all electrical connections (including the mains plug, extension leads and inter-connections between the pieces of equipment) are properly made and in accordance with the manufacturer's instructions. Switch off and withdraw the mains plug before making or changing connections.

DO consult your dealer if you are ever in doubt about the installation, operation or safety of your equipment.

DO be careful with glass panels or doors on equipment.

DO route the mains lead so that it is not likely to be walked on, crushed, chafed, or subjected to excessive wear and tear or heat.

DON'T remove any fixed cover as this may expose dangerous voltages.

DON'T obstruct the ventilation openings of the equipment with items such as newspapers, tablecloths, curtains, etc. Overheating will cause damage and shorten the life of the equipment.

DON'T allow electrical equipment to be exposed to dripping or splashing, or objects filled with liquids, such as vases, to be placed on the equipment.

Safety Information

DON'T place hot objects or naked flame sources such as lighted candles or nightlights on, or close to equipment. High temperatures can melt plastic and lead to fires.

DON'T use makeshift stands and **NEVER** fix legs with wood screws - to ensure complete safety always fit the manufacturer's approved stand or legs with the fixings provided according to the instructions.

DON'T use equipment such as personal stereos or radios so that you are distracted from the requirements of traffic safety. It is illegal to watch television whilst driving.

DON'T listen to headphones at high volume, as such use can permanently damage your hearing.

DON'T leave equipment switched on when it is unattended unless it is specifically stated that it is designed for unattended operation or has a stand-by mode. Switch off using the switch on the equipment and make sure that your family know how to do this. Special arrangements may need to be made for infirm or handicapped people.

DON'T continue to operate the equipment if you are in any doubt about it working normally, or if it is damaged in any way - switch off, withdraw the mains plug and consult your dealer.

ABOVE ALL

--- **NEVER let anyone especially children push anything into holes, slots or any other opening in the case - this could result in a fatal electrical shock;**

--- **NEVER guess or take chances with electrical equipment of any kind**

--- **it is better to be safe than sorry!**

Power source

- The TV should be operated only from a 220-240 V AC, 50 Hz outlet.
- **Warning:** Do not leave your TV in standby or operating mode when you leave your house.

Positioning the TV

- For ventilation, please leave a clear space of at least 10cm all around the TV.

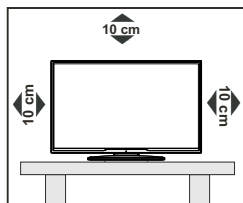

- **Do not** block the ventilation openings.
- **Do not** place the TV on sloping or unstable surfaces, the TV may tip over.
- To prevent damage to the TV, **do not** place any objects on top of the TV.
- Only use the TV in moderate climates.

Power cord and plug

- Do not place the set, a piece of furniture, etc. on the power cord (mains lead) or pinch the cord. Handle the power cord by the plug. Do not unplug the appliance by pulling from the power cord and never touch the power cord with wet hands as this could cause a short circuit or electric shock. Never make a knot in the cord or tie it with other cords. The power cords should be placed in such a way that they are not likely to be stepped on. A damaged power cord can cause fire or give you an electric shock. When it is damaged and needs to be replaced, it should be done by qualified personnel.
- This TV receiver is supplied with a moulded mains plug. The mains plug must not be cut off, as it may contain a special radio interference filter, the removal of which could lead to impaired performance. If you wish to extend the lead, obtain an appropriate safety approved extension lead or consult your dealer.
- Observe the manufacturers instructions when connecting extension leads to the set. Check the fuse rating on the new plug; this should be fitted with a 5 Amp fuse which conforms to either ASTA or BSI (BS1362) approvals, these are easily identifiable by either the ⚡ or ⚡ symbols. If you are in any doubt about the installation of an extension lead, please consult a competent electrician.

Moisture and Water

- **Do not** use this TV in a humid or damp place (avoid bathrooms, the sink in the kitchen, and near the washing machine).
- **Do not** expose this TV to rain or water, as this may be dangerous.
- **Do not** place objects filled with liquids, such as flower vases, on top of the TV. Avoid from dripping or splashing.
- If any solid object or liquid falls into the cabinet, unplug the TV and have it checked by qualified personnel before operating it any further.

Ventilation

- The slots and openings on the TV set are intended for ventilation and to ensure reliable operation.
- To prevent overheating, these openings must not be blocked or covered in anyway.

Safety Information

Heat sources and Flames

- **Do not** expose the TV to direct sunlight or other heat sources.
- The TV should not be placed near to open flames and sources of intense heat such as an electric heater.
- Ensure that no open flame sources, such as lighted candles, are placed on top of the TV.



Headphone Volume

- Excessive sound pressure from earphones and headphones can cause hearing loss, please take care.



Wall Mounting (optional)

- To prevent injury, this TV must be securely attached to the wall in accordance with the installation instructions (if the option is available).

LCD Screen

- Occasionally, a few non-active pixels may appear on the screen as a fixed blue, green or red point. Please note that this does not affect the performance of your product.
- Take care not to scratch the screen with fingernails or other hard objects.

Cleaning

- Before cleaning, unplug the TV from the wall socket.
- **Do not** use liquid or aerosol cleaners. Only use a soft, dry cloth.

Batteries

- **Warning:** Incorrect installation of batteries may cause battery leakage and corrosion, resulting in damage to the remote control.



- **Do not** mix old and new batteries, or batteries of different types.
- **Do not** dispose of batteries in a fire.
- **Do not** dispose of batteries with normal household waste, take to a local recycling centre.

CAUTION: Insert the batteries / rechargeable batteries in the correct polarity. Don't try to recharge non rechargeable batteries and under no circumstances throw them into fire. Danger of explosion. Do not use unequal batteries (old and new, Alkaline and carbon, etc.) simultaneously. If you will not use the device for a long time, remove the batteries and store the device in a dry and dust free place. Improper use of batteries may cause an explosion or leakage. If the batteries have leaked, use gloves and clean the appliance thoroughly with a dry cloth! Batteries should not be exposed to heat, such as sunshine, fire or the like.

Replacement Parts

When replacement parts are required, make sure that the service technician has used replacement parts, which are specified by the manufacturer or have the same specifications as the original one. Unauthorised substitutions may result in fire, electrical shock or other hazards.

Taking out of service and storing

Unplug the TV from the mains and pack the TV in an appropriate cardboard box. Remove the batteries from the remote control and pack the remote control with the TV set.



NOTE: The TV set should be stored in a dry and dust-free room.

Connection to a Television Distribution System (Cable TV etc.) from Tuner

Device connected to the protective earthing of the building installation through the mains connection or through other apparatus with a connection to protective earthing-and to a television distribution system using coaxial cable, may in some circumstances create a fire hazard.

Connection to a cable distribution system has therefore to be provided through a device providing electrical isolation below a certain frequency range (galvanic isolator, see EN 60728-11).

Safety Information

Symbols in this Instruction Book

The following symbols are used in the Instruction Book as a marker for restrictions and precautions and safety instructions. Note such information for security reasons.

WARNING

If you do not pay attention to such a marked warning, it can cause serious injury or death. Note these warnings strictly, in order to ensure a safe operation.

CAUTION

Such a precaution is marked, you should take up or note, to avoid injury or property damage. Note these instructions strictly, in order to ensure a safe operation.

IMPORTANT

Warnings on the appliance and restrictions are displayed like this. Read this information strictly in order to operate the system correctly and avoid damage.

 **NOTE:** Information about the operation and additional explanations are marked like this. To be aware of such information is recommended to ensure that the functions can be used optimally.

The illustrations and the OSD in this operation manual are for explanation purposes and may vary slightly from the actual operations.

CAUTION

Do not put your fingers in the middle between the TV and stand, especially when you carry the TV, as they may be injured.

Occasionally, a few non-active pixels may appear on the screen as a fixed blue, green or red point. Please note that this does not affect the performance of your product. Take care not to scratch the screen with fingernails or other hard objects.

Technical experts are available 7 days a week

- **Simple help and advice on setting up your digital equipment (image).**
- **Guidance on connecting other devices to your television such as a DVD player, Sky, home cinema system or a games console.**
- **Order spare parts, including that lost remote control.**
- **Any other technical issues you may need assistance with.**

Call us today: 0845 604 0105

Local call rates applies*

Lines open 9am-8pm Monday to Saturday and 10am-4pm Sunday.

*Calls to Argos enquiry lines may attract a charge and set up fee from residential lines depending on your call plan/tariff. Mobile and other providers costs may vary, see www.bt.com/pricing for details.

For Security and training purposes, telephone calls to and from customer service centres maybe recorded and monitored. Calls from Republic of Ireland will attract international call charges.

Environmental Information

This television is designed to consume less energy to help save the environment. You can not only help to save the environment but you can also save money by reducing your electricity bills thanks to the energy efficiency features of this TV. To reduce energy consumption, you should take the following steps:

You can use the Power Save Mode setting, located in the Picture menu. If you set the Power Save Mode as Eco, the TV will switch to energy-saving mode and the luminance level of TV set will be decreased to the optimum level. Note that some picture settings will be unavailable to be changed when the TV is in Power Save Mode.

If Picture Off is selected, "Screen will be off in 15 seconds." message will be displayed on the screen. Select PROCEED and press OK to continue. The screen will be off in 15 seconds.

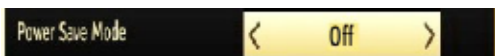

If Picture Off is selected, "**Screen will be off in 15 seconds.**" message will be displayed on the screen. Select PROCEED and press OK to continue. The screen will be off in 15 seconds. If you disable Power Save Mode, Picture mode will be automatically set to Dynamic.

When the TV is not in use, please switch off or disconnect the TV from the mains plug. This will also reduce energy consumption.

Disconnect power when going away for longer time.

It is highly recommended that you activate the Power Save Mode setting to reduce your annual power consumption. And also it is recommended to disconnect the TV from the mains plug to save energy more when you do not use.

Please help us to save environment by following these steps.

Repair Information

Please refer all servicing to qualified personnel. Only qualified personnel must repair the TV. Please contact your local dealer, where you have purchased this TV for further information.

Accessories included

- Remote Control
- Batteries: 2 x AAA
- Instruction Book
- Side AV Connection Cable
- Nero Media Home CD
- Quick Start Guide
- Stand assembly, screws and instructions

Optional Accessories

Wi-Fi

If you would like to connect your TV to a Wi-Fi network, you will need to purchase a dedicated wireless USB dongle.

WEBCAM

If want use the Skype facility on your TV's internet portal, you will need to purchase a dedicated webcam.

TV - Features

- Remote controlled colour TV.
- Fully integrated digital TV (DVB-T-C).
- HDMI connectors for digital video and audio. This connection is also designed to accept high definition signals.
- USB input.
- 1000 programmes.
- OSD menu system.
- Scart socket for external devices (such as video, video games, audio set, etc.).
- Stereo sound system.
- Headphone connection.
- Automatic programming system.
- Forward or backward manual tuning.
- Automatic power down after up to six hours.
- Sleep timer.
- Child lock.
- Automatic sound mute when no transmission.
- NTSC playback.
- AVL (Automatic Volume Limiting).
- PLL (Frequency Search).
- PC input.
- Plug&Play for Windows 98, ME, 2000, XP, Vista, Windows 7, Windows 8.
- Game Mode (optional).
- Picture off function.
- Ethernet (LAN) for Internet connectivity and service.
- 802.11n WIFI Support (Optional).
- DLNA.

Viewing the TV

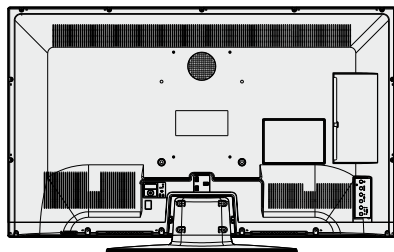
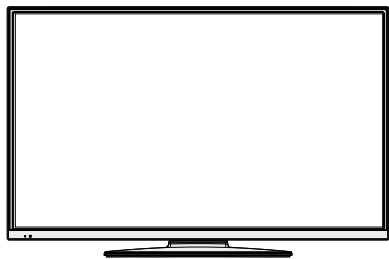

TV Control button & Operation

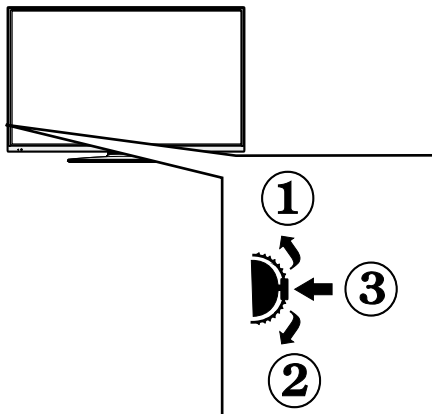

1. Up direction

2. Down direction

3. Programme/Volume / AV / Standby-On selection switch

The Control switch allows you to control the Volume/ Programme/ Source and Standby-On functions of the TV.

To change volume: Increase the volume by pushing the button up. Decrease the volume by pushing the button down.

To change channel: Press the middle of the button, the channel information banner will appear on screen. Scroll through the stored channels by pushing the button up or down

To change source: Press the middle of the button twice, the source list will appear on screen. Scroll through the available sources by pushing the button up or down.

To turn the TV off: Press the middle of the button in and hold it down for a few seconds, the TV will turn into standby mode.



NOTE: You can move the switch, upward or downward to change the volume. If you want to change the channel, press the middle of the switch once (Position 3) and then move upward or downward. If you press the middle of the switch once more, the source OSD will be displayed. To select desired source, move the switch upward or downward and release. If you press the middle of the switch and hold for a few seconds, the TV will switch to standby mode. The Main menu OSD cannot be displayed via the control buttons on the TV.

Viewing remote control - TV

1. Standby
2. Numeric buttons
3. TV-AV / Channel List / DVB-T
4. Volume up/down
5. Mute
6. Navigation buttons
7. Menu on/off
8. OK / Channel List
9. Return/Back
10. Internet portal
11. Media Browser
12. My button 1 (*)
13. Coloured Buttons
14. Mono-Stereo Dual I-II / Audio-Subtitle Language
15. Subtitle on-off / Subtitle (in Media Browser mode)
16. Rewind (in Media Browser mode)
17. No Function
18. Play (in Media Browser mode)
19. Stop (in Media Browser mode)
20. Pause (in Media Browser mode)
21. Fast Forward (in Media Browser mode)
22. Image size
23. Teletext
24. My button 2 / Channel network type (**)
25. Electronic Programme Guide
26. Exit
27. Quick menu
28. Info
29. Programme Up-Down
30. Previous programme
31. AV / Source selection

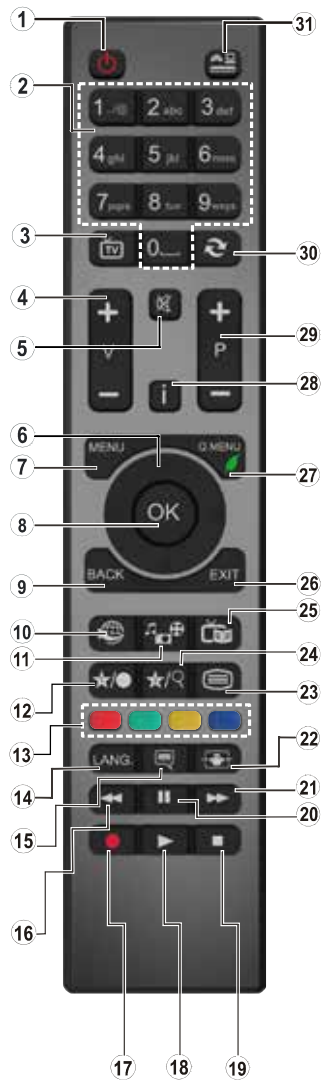

 **NOTE:** The Remote Control range is approximately 7m / 23ft.













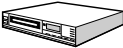



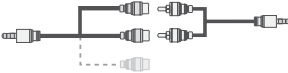

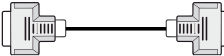
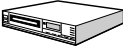





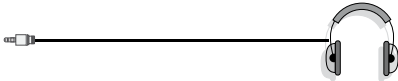

Using My button 1 (*)

This button's main function is to run Youtube link. However, if you want to change this function, you can press MY BUTTON 1 for five seconds when on a desired source, channel or link, until the "MY BUTTON IS SET" message is displayed on the screen. This confirms that the selected MY BUTTON is now associated with the selected function. Note that if you perform first time installation, MY BUTTON 1 will return to its default function

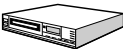
Using My Button 2 (**)

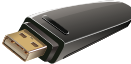
Press MY BUTTON 2 for five seconds when on a desired source, channel or link, until the "MY BUTTON IS SET" message is displayed on the screen. This confirms that the selected MY BUTTON is now associated with the selected function.

Viewing the Connections

Connector	Type	Cables	Device
	Scart Connection (back)		
	VGA Connection (back)		
SIDE AV 	PC/YPbPr Audio Connection (side)	 Side Audio/Video Connection Cable (Supplied) PC Audio Cable (Not supplied)	
	HDMI Connection (back)		
 SPDIF	SPDIF Connection (back)		
SIDE AV 	Side AV Connection (side)	 AV Connection Cable (supplied)	
HEADPHONE 	Headphone Connection (side)		
 PC to YPbPr	YPbPr Video Connection (back)	 PC to YPbPr Connection Cable	
	USB Connection (side)		
	CI Connection (side)		

 **NOTE:** When connecting a device via the Side AV input, you must use the supplied connection cables to enable connection. See the illustrations above. | YPbPr can be used only when you connect a device that has a YPbPr output through the PC input with YPbPr to PC cable (YPbPr to PC cable is not supplied). When the connection is made, switch to YPbPr source. To enable PC audio, you will need to use PC/YPbPr AUDIO CONNECTION WHITE & RED inputs. | If an external device is connected via the SCART socket, the TV will automatically switch to AV mode. | When receiving DTV channels (Mpeg4 H.264) or while in Media Browser mode, output will not be available via the scart socket. | When using the wall mounting kit (optional), we recommend that you plug all your cables into the back of the TV before mounting on the wall. | Insert or remove the CI module only when the TV is SWITCHED OFF. You should refer to the module instruction manual for details of the settings. Insert the CAM and then the viewing card to the slot that is located in the terminal cover at the rear side of the TV. The module should be correctly inserted, it is impossible to insert fully if reversed. The CAM or the TV terminal may be damaged if the CAM is forcefully inserted.

Using a Conditional Access Module

 **IMPORTANT:** Insert or remove the CI module only when the TV is SWITCHED OFF.

In order to watch certain digital channels, a conditional access module (CAM) can be necessary. This module must be inserted in the CI slot of your TV.

1. Obtain the Conditional Access Module (CAM) and the viewing card by subscribing to a pay channel company, then insert those to the TV using the following procedure.

2. Insert the CAM and then the viewing card to the slot that is located in the terminal cover at the rear side of the TV.

3. The CAM should be correctly inserted, it is impossible to insert fully if reversed. The CAM or the TV terminal may be damaged if the CAM is forcefully inserted.

4. Connect the TV to the mains supply, switch on and then wait for few moments until the card is activated.

5. When no module is inserted, “**No Common Interface module detected**” message appears on the screen.

You can refer to the module instruction manual for details of the settings.

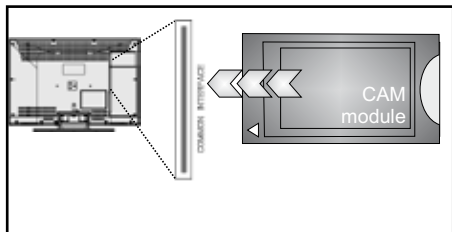

Standby Notifications

If the TV does not receive any input signal (e.g. From an aerial or HDMI source) for 5 minutes, the TV will go into standby. When you next switch-on the TV, the following message will be displayed:



When the Auto Tv Off timeout is reached, the following message will be displayed on the screen. Select YES to shut down the TV. Select NO to cancel. The TV will switch off as well, if you do not make a selection on this screen.

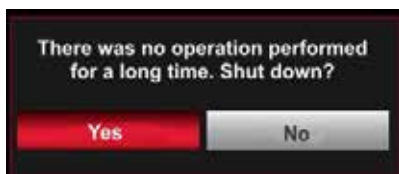

If the TV has been left on and not been operated for 4 hours, the TV will go into standby. When you next switch-on, the following message will be displayed:



Installing the Batteries to the Remote

1. Lift the cover on the back of the remote upward gently.
2. Install two AAA batteries. Make sure to match the + and - ends of the batteries in the battery compartment (observe the correct polarity).
3. Replace the cover.

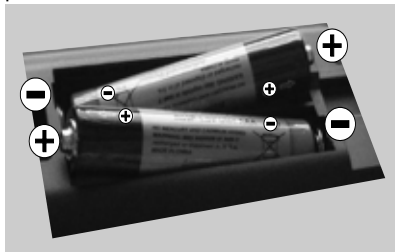

Connect Power

IMPORTANT: The TV set is designed to operate on **220-240V AC, 50 Hz** socket. After unpacking, allow the TV set to reach the ambient room temperature before you connect the set to the mains. Plug the power cable to the mains socket outlet.

Antenna Connection

Connect the “aerial” plug to the AERIAL INPUT (ANT) socket located on the back of the TV.

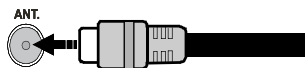

Switching On/Off

To Switch the TV On

Connect the power cord to the 220-240V AC, 50 Hz.

To switch on the TV from standby mode either:

Press the “” button, **P+** / **P-** or a numeric button on the remote control.

Press the side function switch until the TV comes on from standby.

To Switch the TV Off

Press the “” button on the remote control or press the side function switch until the TV switches into standby mode.

To power down the TV completely, unplug the power cord from the mains socket.

Note: When the TV is switched to standby mode, the standby LED can blink to indicate that features such as Standby Search, Over Air Download or Timer is active. The LED can also blink when you switch on the TV from standby mode.

First Time Installation

When turned on for the first time, the “language selection” menu appears. The message “**Welcome please select your language!**” is displayed in all language options listed alphabetically.



Press the “” or “” button to highlight the required language, press **OK** button to select. “First Time Installation” appears. Use “” or “” button to set the required country, and press “” button to select Search Type. Use “” or “” to set the desired search type. Available search types are Digital and analog, digital only and analog only. When set, press “” to select Teletext Language. Use “” or “” button to set the “Teletext Language” and select “Scan Encrypted” using “” or “” button. You can set **Scan Encrypted** as **Yes** if you want to scan coded stations.



Default PIN code can change depending on the selected country.

If you are asked to enter a PIN code for viewing a menu option, use one of the following codes: 4725, 0000 or 1234.

Press **OK** button on the remote control to continue and the following message will be displayed on the screen.

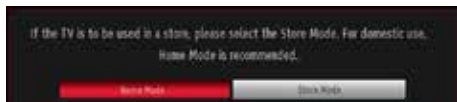

You can activate Store mode option by using “<” or “>” button. If Store Mode is selected, Store mode option will be available in other settings menu and your TV's features will be illustrated on the top of the screen. A confirmation screen will be displayed after selecting the Store Mode. Select **YES** to proceed.



If Home Mode is selected, Store mode will not be available after the First Time Installation. Press **OK** button on the remote control to continue and the following message will be displayed on the screen.

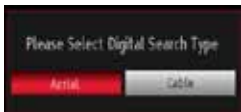

You must select a search type to search and store broadcasts from the desired source.

Aerial Installation

If you select **AERIAL** option from the **Search Type** screen, the television will search for digital terrestrial TV broadcasts.



NOTE: You can press **MENU** button to cancel.

After all the available stations are stored, Channel List will be displayed on the screen. If you like the sort channels, according to the LCN(*), please select “Yes” and than press **OK**.



Press **OK** button to quit channel list and watch TV.

(*) LCN is the Logical Channel Number system that organizes available broadcasts in accordance with a recognizable channel sequence.

Note: As the Cable feature is not supported in the UK, please ensure that you select Aerial during the First Time Installation. If you mistakenly select Cable, please repeat the First Time Installation (which can be selected from the tuning menu) and select Aerial.

Media Playback via USB Input

You can connect a USB hard disk drive or USB memory stick to your TV by using the USB inputs of the TV. This feature allows you to play files stored in a USB drive. 2.5" and 3.5" inch (hdd with external power supply) external hard disk drives are supported.

IMPORTANT! You should back up your files before making any connections to the TV set in order to avoid any possible data loss. Manufacturer will not be responsible for any file damage or data loss. It is possible that certain types of USB devices (e.g. MP3 Players) or USB hard disk drives/memory sticks may not be compatible with this TV.

Quickly plugging and unplugging USB devices, is a very hazardous operation. Do not repeatedly quickly plug and unplug the drive. This may cause physical damage to the USB player and USB device itself. Do not pull out USB module while playing a file.

Media Browser Menu

You can play photo, music, and movie files stored on a USB disk by connecting it to your TV and using the Media Browser screen. To do this, perform the following: Connect a USB disk to one of the USB inputs located on the side of the TV.



You can connect two USB devices to your TV. If both USB devices include music, picture or video files, USB selection OSD will be displayed on the screen. The first USB device connected to the TV will be named as USB Drive1. Select a device by using “v” or “^” button and press **OK**.

Press **MENU** button and select Media Browser tab by using Left/Right and **OK** buttons. Main media browser screen will be displayed. You can display the related content by selecting the Video, Music or Picture tab. Follow the button indications under each on screen menu for media playback features.

You can set your Media Browser preferences by using the Settings dialog.

Using MENU button in Media Browser Mode

Pressing **MENU** button in Media Browser mode displays the following menu screen:



You can access **Picture**, **Sound** and **Settings** menu options using this screen. Press **MENU** again to exit from this screen.

Select Channel List item by using **Left** or **Right** button. Press **OK** to view menu contents. Select **Edit Channel List** to manage all stored channels. Use **Up** or **Down** and **OK** buttons to select **Edit Channel List**. Press **Up** or **Down** button to select the channel that will be processed. Press **Left** or **Right** button to select a function on Channel List menu. Use **P+/P-** buttons to move page up or down. Press **MENU** button to exit.

Sorting Channel List

You can select broadcasts to be listed in the channel list. To display specific types of broadcast, you should use Active channel list setting. Select Active channel list from the Channel list menu by using "**^**" or "**v**" button. Press **OK** button to continue. You can select a network type option from the list by using "**<**" or "**>**" and **OK** buttons.

Quick Menu

Quick Settings menu allows you to access some options quickly. This menu includes **Power Save Mode**, **Picture Mode**, **Equalizer Settings**, **Favourites** and **Sleep Timer** options. Press **Q.MENU** button on the remote control to view quick menu. See the following chapters for the details of the listed features.

Changing Image Size: Picture Formats

Programmes can be watched in different picture formats, depending on the transmission received. You can change the aspect ratio (image size) of the TV for viewing the picture in different zoom modes. Press "**+**" button repeatedly to change the image size. **You can shift the screen up or down by using "**^**" or "**v**" buttons while in, 14:9 Zoom, Cinema or Subtitle.**

Using the Channel List



The TV sorts all stored stations in the Channel List. You can edit this channel list, set favourites or set active stations to be listed by using the Channel List options. Press **MENU** button to view main menu.



Menu Features and Functions

Picture Menu Contents	
Mode	For your viewing requirements, you can set the related mode option. Picture mode can be set to one of these options: Cinema, Game, Dynamic , Sport and Natural .
Contrast	Sets the lightness and darkness values of the screen.
Brightness	Sets the brightness value for the screen.
Sharpness	Sets the sharpness value for the objects displayed on the screen.
Colour	Sets the colour value, adjusting the colors.
Power Save Mode	To set the Power Save Mode as Eco, Picture Off and Disabled. When the Mode is Dynamic, Power Save mode is automatically set as disabled. Selecting the Picture mode as Natural, does not automatically enable Power Save mode as Eco.
Backlight (optional)	This setting controls the backlight level and it can be set to Auto, Maximum, Minimum and Eco Mode . <i>Backlight function will be inactive if Power Save Mode is set to On. Backlight cannot be activated in VGA, Media Browser mode or while the picture mode is set to Game.</i>
Noise Reduction	If the broadcast signal is weak and the picture is noisy, use Noise Reduction setting to reduce the noise amount. Noise Reduction can be set to one of these options: Low, Medium, High or Off .
Advanced Settings	
Dynamic Contrast	You can change contrast rate by using dynamic contrast function. Dynamic contrast can be set to one of these options: Low, Medium, High or Off .
Colour Temp	Sets the desired colour tone.
Picture Zoom	Sets the picture size to Auto, 16:9, Subtitle, 14:9, 14:9 Zoom, 4:3 or Cinema.
HDMI True Black	While watching from HDMI source, this feature will be visible in the Picture Settings menu. You can use this feature to enhance blackness in the picture.
Film Mode	Films are recorded at a different number of frames per second to normal television programmes. Turn this feature on when you are watching films to see the fast motion scenes clearly.
Skin Tone	Adjust the desired skin tone.
Colour Shift	Adjust the desired colour tone.
RGB Gain	Press OK button to edit RGB gain. You can configure the colour temperature values using the RGB Gain feature.
Reset	Resets the picture settings to factory default settings.
Autoposition (in PC mode)	Automatically optimizes the display. Press OK to optimize.
H Position (in PC mode)	This item shifts the image horizontally to right hand side or left hand side of the screen.
V Position (in PC mode)	This item shifts the image vertically towards the top or bottom of the screen.
Dot Clock (in PC mode)	Dot Clock adjustments correct the interference that appear as vertical banding in dot intensive presentations like spreadsheets or paragraphs or text in smaller fonts.
Phase (in PC mode)	Depending on the resolution and scan frequency that you input to the TV set, you may see a hazy or noisy picture on the screen. In such a case you can use this item to get a clear picture by trial and error method.
<i>While in VGA (PC) mode, some items in Picture menu will be unavailable. Instead, VGA mode settings will be added to the Picture Settings while in PC mode.</i>	

Menu Features and Functions

Sound Menu Contents	
Volume	Adjusts volume level.
Equalizer:	In equalizer menu, the preset can be changed to Music, Movie, Speech, Flat, Classic and User . Press the MENU button to return to the previous menu. <i>Equalizer menu settings can be changed manually only when the Equalizer Mode is in User.</i>
Balance	This setting is used for emphasizing left or right speaker balance.
Headphone/Lineout	When you connect an external amplifier to your TV using the headphone jack, you can select this option as Lineout. If you have connected headphones to the TV, set this option as Headphone. Please ensure before using headphones that this menu item is set to Headphones. If it is set to Line Output, The output from the headphone socket will be set to maximum which could damage your hearing. Also please ensure before using headphones that the headphone volume is set to a low level, to prevent damage to your hearing. Please only use Headphone option for connecting external devices like <u>soundbar</u> .
Sound Mode	You can select Mono, Stereo, Dual I or Dual II mode, only if the selected channel supports that mode.
AVL	Automatic Volume Limiting (AVL) function sets the sound to obtain fixed output level between programmes (For instance, volume level of advertisements tend to be louder than programmes).
Dynamic Bass	Enables or disables the Dynamic Bass.
Surround Sound	Surround sound mode can be changed as On or Off.
Digital Out	Sets digital out audio type.
Install and Retune Menu Contents	
Automatic Channel Scan (Retune)	Displays automatic tuning options. <i>Digital Aerial: Searches and stores aerial DVB stations.</i> <i>Digital Cable: Searches and stores cable DVB stations.</i> <i>Analogue: Searches and stores analogue stations.</i> <i>Digital Aerial & Analogue: Searches and stores aerial DVB and analogue stations.</i> <i>Digital Cable & Analogue: Searches and stores cable DVB and analogue stations.</i>
Manual Channel Scan	This feature can be used for direct broadcast entry.
Network Channel Scan	Searches for the linked channels in the broadcast system.
Analogue Fine Tune	You can use this setting for fine tuning analogue channels. This feature is not available if no analogue channels are stored.
First Time Installation	Deletes all stored channels and settings, resets TV to factory settings and starts first time installation. You can follow the instructions in the Initial Installation section for more information on this process. <i>Factory-default PIN number is 0000.</i>
Clear Service List	(*) This setting is visible only when the Country option is set to Denmark, Sweden, Norway or Finland. Use this setting to clear channels stored.

Menu Features and Functions

Settings Menu Contents	
Conditional Access	Controls conditional access modules when available.
Language	Configures language settings.
Parental	Configures parental settings. Default PIN code can change depending on the selected country. If you are asked to enter a PIN code for viewing a menu option, use one of the following codes: 4725, 0000 or 1234. Internet lock feature can be enabled/disabled in parental menu. When Internet lock is active, portal is inaccessible.
Timers	Sets timers for selected programmes.
Date/Time	Sets date and time.
Sources	Enables or disables selected source options.
Network Settings	Displays network settings.
Other Settings: Displays other setting options of the TV set:	
Menu Timeout	Changes timeout duration for menu screens.
Scan Encrypted	When this setting is on, search process will locate the encrypted channels as well. If it is set as Off , encrypted channels will not be located in automatic search or manual search.
Blue Background	Activates or deactivates blue background system when the signal is weak or absent.
Software Upgrade	To ensure that your TV always has the most update information, you can use this setting. In order for the proper operation, please ensure that the TV is set to standby mode.
Application Version	Displays application version.
Hard of Hearing	If the broadcaster enables any special signal concerning the audio, you can set this setting as On to receive such signals.
Audio Description	Audio description refers to an additional narration track for blind and visually impaired viewers of visual media, including television and movies. You can use this feature, only if the broadcaster supports that additional narration track.
Auto TV Off	You can set the timeout value of auto off feature. After the timeout value is reached and the TV is not operated for selected time, the TV will go off.
Standby Search (optional)	If you change Standby Search to Off , this function will be unavailable. To use Standby search please make sure that you select Standby Search as On . If the Standby Search is set to On , when the TV is in standby mode, available broadcasts will be searched. If the TV locates any new or missing broadcasts, a menu screen will be displayed, asking you whether or not to execute these changes. Channel list will be updated and changed after this process. Please activate Standby Search setting in order to enable your TV for automatically updating the broadcast frequency of the broadcaster, broadcast definition and similar changes.
Store Mode	If you are displaying the TV in a store, you can activate this mode. While Store Mode is enabled, some items in the TV menu may not be available to be set.
DLNA Renderer	DLNA renderer feature allows you to share files stored on your smartphone. If you have a DLNA renderer compatible smartphone and software installed, you can share/play photos with your TV. See instructions of your sharing software for more information.
Power Up Mode	This setting configures the power up mode preference. Always On: The TV always switches on when main on/off button is pressed. / Standby: The TV always powers up in Standby mode. / Last State: The TV always switches on with the last selected channel/source.
Virtual Remote	Enables or disables the virtual remote feature.

Electronic Programme Guide (EPG)

Some, but not all channels send information about the current and next programmes. Press the “” button to view the EPG menu.

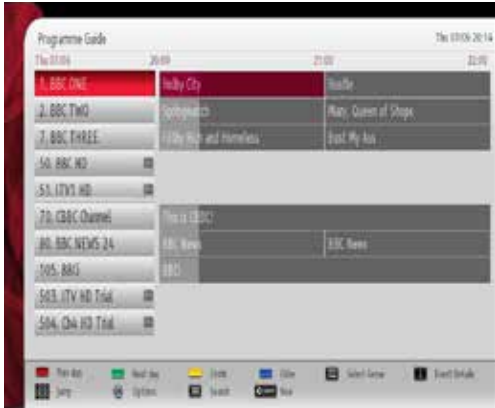

Up/Down/Left/Right: Navigate EPG.

Red button (Prev Day): Displays the programmes of previous day.

Green button (Next day): Displays the programmes of the next day.

Yellow button (Zoom): Expands programme information.

Blue button (Filter): Views filtering options.

“i”: Displays, in detail information on programme selected.

SUBTTL: Press “” button to view Select Genre menu. Using this feature, you can search the programme guide database in accordance with the genre. Info available in the programme guide will be searched and results matching your criteria will be listed.

Numeric buttons (Jump): Jumps to the preferred channel directly via numeric buttons.

OK: Displays programme options.

Text (Search): Displays “**Guide Search**” menu.

↻SWAP (Now) : Shows the current programme.

Connectivity Functions

Connecting to a Wired Network

For connecting to a wired LAN network, you should perform the following steps:

- Connect broadband ISP connection ethernet cable to the ETHERNET INPUT of your modem.
- Ensure that Nero Media Home software is installed to your PC.(for DLNA function). See Appendix G for more information on the installation process.

- Afterwards, you should connect your PC to the one of your modem’s LAN connectors (e.g. LAN 1) by using a proper LAN cable.
- Use another LAN output of your modem (e.g. LAN 2) to enable the connection to your TV. You can add your TV to your LAN by connecting the LAN port at the rear of your TV to your modem’s LAN connector as illustrated.

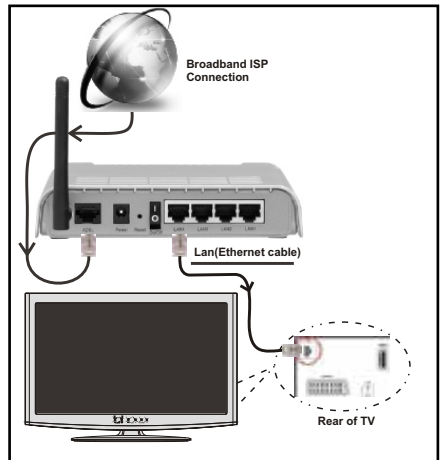

- To access and play shared files, you must select Media Browser. Press Menu button and select Media Browser by using Left or Right button. Press OK to continue. Select the desired file type and press OK. You must always use the Media Browser screen to access and play shared network files.
- PC/HDD/Media Player or any other devices that are DLNA 1.5 compatible should be used with wired connection for higher playback quality.

To configure wired settings please refer Network Settings section in Settings menu.

- You might be able to connect your TV to your LAN network depending on your network’s configuration. In such a case, use an ethernet cable to connect your TV directly to the network wall outlet.

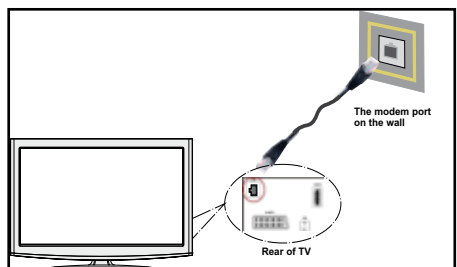

Connecting to a Wireless Network

IMPORTANT: A dedicated wireless USB dongle (available from your dealer) is required for Wi-Fi operation.

- To use your TV with your wireless network, you need a dedicated wireless USB dongle. To make your modem's SSID visible, you should change your SSID settings via modem's software. The TV cannot connect to the networks with hidden SSID.

For connecting to a wireless LAN network, you should perform the following steps:

1. Connect broadband ISP connection ethernet cable to the ETHERNET INPUT of your modem.
2. Ensure that Nero Media Home software is installed to your PC (for DLNA function).
3. Afterwards, you should connect wireless adaptor to one of the USB inputs of the TV.
4. To configure wireless settings please refer Network Settings section in the following sections.

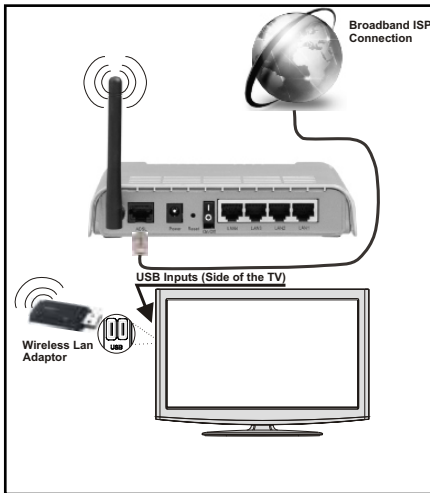

- A Wireless-N router (IEEE 802.11a/b/g/n) with simultaneous 2.4 and 5 GHz bands designed to increase bandwidth. Optimized for smoother and faster HD video streaming, file transfers, and wireless gaming.
- Use LAN connection for quicker file sharing between other devices like computers.
- The frequency and channel differ depending on the area.
- The transmission speed differs depending on the distance and number of obstructions between the transmission products, the configuration of these products, the radio wave conditions, the line traffic, and the products that you use. The transmission may also be cut off or get disconnected depending on the radio wave conditions DECT phones, or any

other WiFi 11b appliances. The standard values of the transmission speed are the theoretical maximum values for the wireless standards. They are not the actual speeds of data transmission.

- The location where the transmission is most effective differs depending on the usage environment.
- Wireless LAN adaptor should be connected directly to the TV's USB port. USB hubs are not supported.
- To configure wireless settings please refer wifi section in Settings menu.
- Wireless LAN adaptor supports 802.11 a,b,g & n type modems. It is highly recommended that you should use IEEE 802.11n communication protocol in order to avoid any possible problems while watching videos.
- Use the other usb input, if you experience problems with audio/video performance.
- You must change your modem's SSID when there are any other modems around with the same SSID. You can encounter connection problems otherwise. Use wired connection instead if you experience problems with wireless connection.

Configuring Network Settings

Your TV's Network Settings include Wired and Wireless Connection options. However, if your TV does not have USB Wi-Fi dongle (sold separately), you should use Wired Connection type. If you try to connect via Wireless Connection when your TV does not have a USB Wi-Fi dongle, a warning screen will appear and the TV will not get an IP address. Try connecting the LAN cable after this and then the TV will be able to get an IP address.

Configuring Wired Device Settings

If you are connecting the TV via ETHERNET INPUT, select Network Type as **Wired Device** to configure.

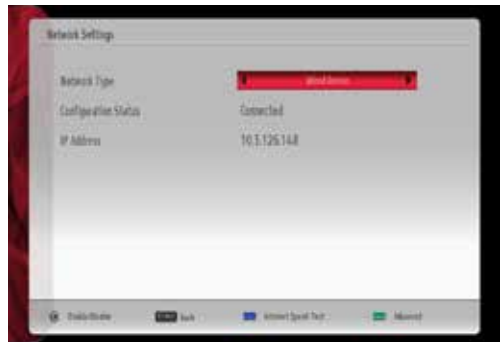

Network Type

Network type can be selected as **Wired** or **Wireless** device, in accordance with the active connection to the TV set. Select this as Wired if you have connected to the TV a LAN cable. Select as Wireless if you connect via the wireless USB dongle (**sold separately**).

Configuration Status

This section displays the status of the connection. Select **Connected** if you want to activate connection. Select as **Not Connected** to end an active connection.

IP Address

If an active connection is available, the IP address will be displayed on this section. If you want to configure IP address preferences, press **GREEN** button and switch to the advanced mode.

Configuring Wired Network Settings in Advanced Mode

After pressing **GREEN** button, Advanced mode will be available. While in Advanced Mode, press **RED** button to edit settings. When finished, press **OK** to save, Press **RETURN/BACK** to cancel.

Configuring Wireless Device Settings (Optional)

To use your TV with your wireless network, you need a dedicated wireless USB dongle which is available from your dealer.

Wi-Fi feature can be used for a wireless network connection. The feature is used for infrastructure purposes only, such as connecting to the web, hbb sites and connecting with DLNA servers (optional). If you have the dedicated Wifi Dongle (*sold separately*), select **Network Type** as **Wireless Device** to start connection process.

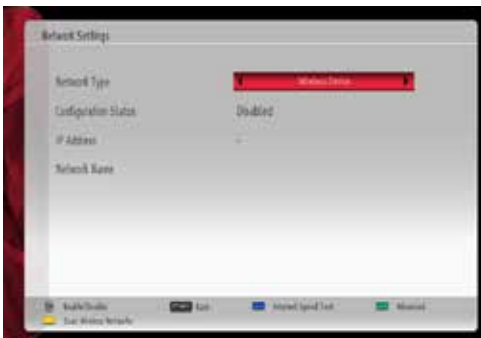

To enable Wi-Fi feature, profiles should be configured properly. Please plug in the Wi-Fi dongle (*sold separately*) to one of the USB ports.

Press **YELLOW** button to scan wireless network from network settings menu. Afterwards, available network list will be displayed. Please select your desired network from the list.

If the selected network is protected with a password, please enter the correct key by using the virtual keyboard. You can use this keyboard via **navigation buttons** (Left/Right/Up/Down) and **OK** button on the remote control.



Wait until the IP the address is shown on the screen.

This means that the connection is now established. To disconnect from a wireless network, you should highlight **Configuration Status** and press **OK**.



You can navigate between menu tabs by pressing left/right buttons. The help bar on the bottom of the dialog shows features that you may use. Press **BLUE** button to check your internet connection speed.

You can check the signal strength by using the network settings menu for the wireless device mode.

Information

Configuration Status: Displays wi-fi status as connected or not connected.

IP Address: Displays the current IP address.

Network Name: Connected networks' name will be displayed.

Press **GREEN** button to switch to advanced mode and then press **OK** button to edit settings.



Delete Saved Wifi Profiles

Saved profiles will be deleted if you press red button while wireless device selection osd is on the screen.

Connecting to your Cell Phone via WiFi (Optional)

- If your cell phone has WiFi feature, you can connect your cell phone to your TV by using WiFi connection via a router, in order to play content from your phone. For this, your cell phone must have an appropriate sharing software.
- Connect to your router following the steps stated above in the Wireless Connection section.
- Afterwards, engage your cell phone with the router and then activate sharing software on your cell phone. Then, select files that you would like to share with your TV.
- If the connection is established correctly, you should now access the shared files of your cell phone via the Media Browser of your TV.
- Enter Media Browser menu and playback device selection OSD will be displayed. Select your cell phone's ident and press **OK** to continue.

 *Note: This feature may not be supported by some cell phones.*

Connectivity Troubleshooting

Wireless Network Not Available

Ensure that the firewalls of your network allows the TV wireless connection. The dedicated usb wifi dongle(sold separately) should be plugged properly (if available). If the wireless network does not function properly, try using the wired network in your home. Refer to the Wired Connection section for more information on the process.

If the Net TV does not function, check the modem (router) first. If the router does not have a problem, check the internet connection of your modem.

Try searching for wireless networks again, using the Network Settings menu screen.

Connection is Slow

See the instruction book of your wireless modem to get information on the internal service area, connection speed, signal quality and other settings. You need to have a high speed connection for your modem.

Distruption during playback or slow reactions

You could try the following in such a case:

Keep at least three meters distance from microwave ovens, mobile telephones, bluetooth devices or any other Wi-Fi compatible devices. Try changing the active channel on the WLAN router.

Using DLNA Network Service

DLNA (Digital Living Network Alliance) is a standard that eases viewing process of digital electronics and makes them more convenient to use on a home network. For further information, visit www.dlna.org.

DLNA standard allows you to view and play photos, music and videos stored in the DLNA media server connected to your home network.

Step 1: Nero Media Home Installation

DLNA function cannot be used if the server program is not installed on your PC. Please prepare your PC with the provided Nero Media Home programme. *For more information about the installation, please refer to appendix H.*

Step 2: Connect to a Wired or Wireless Network

See the chapter Network Settings for detailed configuration information.

Step 3: Play Shared Files via Media Browser

Select **Media Browser** by using **Left** or **Right** button from the main menu and press **OK** button. Media browser will be then displayed.

DLNA support is available only with Media Browser folder mode. To enable folder mode, go to **Settings** tab in the main media browser screen and press **OK**. In the settings options, highlight **View Style** and change to **Folder** using **Left** or **Right** button.

Please select desired media type and press **OK**.



If sharing configurations are set properly, the following OSD message will be displayed after selecting the desired media type. Select **OK** to display the selected network or USB memory content. If you want to refresh the device list, press **GREEN** button. You can press **MENU** to exit.



If available networks are found, they will be listed on this screen. Select media server or network that you want to connect by using “**▲**” or “**▼**” buttons and press **OK** button.

If you select media type as **Video** and choose a device from the selection menu, a new menu screen will appear on the screen as below:



Select **Videos** from this screen to list all the available video files from the selected network.

To play other media types from this screen, you must go back to main Media Browser screen and select media type as desired and then perform the network selection again. Refer to Media Browser USB Playback section for further information on file playback.

Subtitle files do not work if you watch video from network through DLNA.

You can connect only one television with DLNA to same network. If a problem occurs with DLNA network, please switch on/off your television. Trick mode and jump are not supported with DLNA function.

CAUTION:

There may be some PC's which may not be able to utilize the DLNA function due to administrator and security settings. (such as business PC's).

For best home network streaming with this set, the supplied Nero software should be installed.

Internet Portal

You can access PORTAL mode using your TV. To do this, an active internet connection is required. Follow the steps on Connecting to a Wired/Wireless(optional) Network section to connect your TV to internet. After the connection is established, you can select or view portal options.

Note: Broadband internet connection is required for high quality viewing. Ensure that the internet connection is made properly. You must set the Country and Language data correctly in the First Time Installation for the proper operation of internet portal.

Press “**OK**” button on your remote control and portal application options will be displayed. Application options will be displayed as the template below. Available applications' contents may change depending on the application content provider.



Select a link or application using the Left and Right or Up or Down buttons and press **OK** to activate.

- Use Up/Down and Left/Right buttons to navigate between the items on Portal screen.
- Press **OK** button to confirm your selection.
- Press **BACK** to go to the previous screen.
- Press **EXIT** to quit internet portal mode.

Note: Possible application dependent problems may be caused by the content service provider.

Note on PIP Window

If you switch to portal mode while watching TV channels, current programme will be displayed on the PIP window. You can change channels using P+/P- buttons.

Current HDMI content will be displayed on the PIP window, if you switch to portal mode while watching HDMI source.

Use the “**◀**” or “**▶**”, “**▲**” or “**▼**” to navigate between the items on Portal screen. Press the **OK** button to confirm your selection. Press the **BACK** button to go to the previous screen.

Press the **EXIT** button to quit the Internet portal mode.

iPlayer Application

You can access BBC iPlayer using your TV. To do this, an active internet connection is required. (See connecting to a Wired/Wireless Network section to connect your TV to internet). After the connection is established, you can select BBC iPlayer among the portal options. (See Internet Portal)

Press the **OK** button on your remote control to start the BBC iPlayer application.



Note: Broadband internet connection (minimum 2Mbps) is required for high quality viewing.

Playing a Programme via iPlayer

Select a programme and press **OK** button. The programme playback will begin.

You can press the **PAUSE** button to pause playback. Press the **PLAY** button to resume the playback.

Use the **STOP** button to stop the playback.

Press the **EXIT** button to exit iPlayer. Press the **RETURN** button for going back to the previous screen.

Note: "Episode is unavailable." message may be displayed on the screen if a problem occurs during the playback.

Searching a Programme

Highlight the Search tab using the navigation buttons and press the **OK** button. Use the virtual keyboard to type the letters. Select letters and press the **OK** button. When finished, highlight Search option and press the **OK** button.

Teletext

Digital Teletext (for UK only)

• Press the **☰** button. The digital teletext information appears. Operate it with the coloured buttons, cursor buttons and **OK** button.

The operation method may differ depending on the contents of the digital teletext. Follow the instructions displayed on digital teletext screen.

When the **☰** button is pressed again, the TV returns to television broadcasting.

Software Upgrade

Your TV is capable of finding and updating new software upgrades over broadcast channels. For broadcast channels search, TV looks the available channels stored in your settings. So before software upgrade search, it is advised to auto search and update all available channels.

1) Software upgrade search via user interface

• It is possible manually to check if there is a new software upgrade for your TV set.

• Simply navigate on your main menu. Choose **Settings** and select **Other Settings** menu. In **Other Settings** menu navigate on to the **Software Upgrade** item and press **OK** button to open **Upgrade Options** menu.

• In **Upgrade Options** menu select **Scan for upgrade** and press **OK** button.

• If a new upgrade is found, it starts to download the upgrade. A progress bar indicates the remaining download progress. When download completes with success a message is displayed for reboot to activate new software. Press **OK** to continue with the reboot operation.

2) 3.AM search and upgrade mode

• If **Automatic scanning** in **Upgrade Options** menu is enabled, TV wakes up at 03:00 and searches broadcast channels for new software upgrade. If new software is found and downloaded successfully, with next power up TV opens with new software version.

Note on reboot operation: Reboot is the last step in software upgrade operation if download of new software is finished successfully. During reboot TV makes final initialization. In reboot sequence panel power is closed and front led indicates the activity with blinking. Around 5 minutes later TV restarts with new software activated.

• If your TV fails to restart in 10 minutes, unplug power for 10 minutes and re-plug again. TV should open with new software safely. If you still can not get TV working, please kindly repeat unplug and plug sequence a few times more. If your set still can not operate, please call the service personnel to fix the problem for you.

Caution: While led is blinking during reboot do not unplug your TV's power. Doing this may cause your TV not to re-open again and can only be fixed by service personnel.

Troubleshooting & Tips

Image persistence - ghosting

Please note that ghosting may occur while displaying a persistent image (still or paused image). LCD TVs' image persistence may disappear after a short time. Try turning off the TV for a while. To avoid this, do not leave the screen in still picture mode for extended periods.

No power

If your TV has no power, please check the power cord plug is connected to the mains power socket.

Poor picture

1. Have you selected the correct TV system?
2. Is your TV or house aerial located too close to a non-earthed audio equipment or neon lights, etc.?

3. Mountains or high buildings can cause double pictures or ghost images. Sometimes you can improve the picture quality by changing the direction of the aerial. Is the picture or teletext unrecognisable?
4. Check if you have entered the correct frequency.
5. Please retune the channels.
6. The picture quality may degrade when two devices are connected to the TV at the same time. In such a case, disconnect one of the devices.

No picture

1. No Picture means that your TV is not receiving a transmission. Have you selected the correct button on the remote control? Try once more. Also make sure the correct input source has been selected.
2. Is the aerial connected properly?
3. Are the plugs connected tightly to the aerial socket?
4. Is the aerial cable damaged?
5. Are suitable plugs used to connect the aerial?
6. If you are in doubt, consult your dealer.

No sound

1. Has the TV been set to mute? To cancel mute, press the "MUTE" button, or increase the volume level.
2. Sound is coming from only one speaker. Is the balance set to one extreme? See Sound Menu section.

Remote control - does not operate

Your TV no longer responds to the remote control. The batteries may be exhausted, if so you can still use the control buttons on the TV. (* Is only possible if they are not blocked by parental control.)

Input sources - can not be selected

1. If you cannot select an input source, it is possible that no device is connected.
2. Check the AV cables and connections if you have tried to connect a device.

Internet Connection Not Available / DLNA Mode Not Operating

If the MAC address (a unique identifier number) of your PC or modem has been permanently registered, it is possible that your TV might not connect to the internet. In such a case, the MAC address is authenticated each time when you connect to the internet. This is a precaution against unauthorized access. Since your TV has its own MAC address, your internet service provider cannot validate the MAC address of your TV. For this reason, your TV cannot connect to the internet. Contact your internet service provider and request information on how to connect a different device, such as your TV, to the internet.

It is also possible that the connection may not be available due to a firewall problem. If you think

this causes your problem, contact your internet service provider. A firewall might be the reason of a connectivity and discovery problem while using the TV in DLNA mode or while browsing via DLNA.

Invalid Domain

Ensure that you have already logged on to your PC with an authorized username/password and also ensure that your domain is active, prior to sharing any files in your DLNA server program on your PC. If the domain is invalid, this might cause problems while browsing files in DLNA mode.

DVB-T functionality information

This DVB receiver is only suitable for use in the country which it was designed to be used in.

Although this DVB receiver conforms to the latest DVB specifications at the time of manufacture, we cannot guarantee compatibility with future DVB transmissions due to changes that may be implemented in broadcast signals and technologies.

Some digital television functions may not be available in all countries.

We continually strive to improve our products; therefore, specifications may change without prior notice.

For advice on where to purchase accessories, please contact the store where you purchased your equipment.

NB. Both the wireless dongle and the webcam are especially matched to work with your TV and can only be purchased from Argos.

To Program Your SKY Remote For Your TV

5. Make sure your SKY box is connected to your TV
6. Turn your TV and SKY box on
7. Press TV on your SKY remote control handset
8. Hold down SELECT and the RED button together for about two seconds, until the red light on the SKY remote blinks twice.
9. Key in 065 on your SKY remote. The light on the SKY remote should blink twice
10. Press the STANDBY button on your SKY remote control. Your TV should now switch off.
11. Press SELECT again. The light on your SKY remote control should now blink twice

You should now be able to control some basic functions on your TV from your SKY remote control (e.g. volume up/down, programme up/down).

PC Typical Display Modes

The following table is an illustration of some of the typical video display modes. Your TV may not support all resolutions. Your TV supports up to 1920x1200.

Index	Resolution	Frequency
1	640x400	70Hz
2	640x350	85Hz
3	640x400	85Hz
4	640x480	60Hz
5	640x480	66Hz
6	640x480	72Hz
7	640x480	75Hz
8	640x480	85Hz
9	800x600	56Hz
10	800x600	60Hz
11	800x600	70Hz
12	800x600	72Hz
13	800x600	75Hz
14	800x600	85Hz
15	832x624	75Hz
16	1024x768	60Hz
17	1024x768	66Hz
18	1024x768	70Hz
19	1024x768	72Hz
20	1024x768	75Hz
21	1024x768	85Hz
22	1152x864	60Hz
23	1152x864	70Hz
24	1152x864	75Hz
25	1152x864	85Hz
26	1152x870	75Hz
27	1280x768	60Hz
28	1360x768	60Hz
29	1280x768	75Hz
30	1280x768	85Hz
31	1280x960	60Hz
32	1280x960	75Hz
33	1280x960	85Hz
34	1280x1024	60Hz
35	1280x1024	75Hz
36	1280x1024	85Hz
37	1400x1050	60Hz

38	1400x1050	75Hz
39	1400x1050	85Hz
40	1440x900	60Hz
41	1440x900	75Hz
42	1600x1200	60Hz
43	1680x1050	60Hz
44	1920x1080	60Hz
45	1920x1200	60Hz

Specifications

TV BROADCASTING

PAL/SECAM B/G D/K K' I/I' L/L'

DIGITAL RECEPTION

DVB-T MPEG2

DVB-T MPEG4 HD

DVB-T MHEG-5 Engine (for UK only)

DVB-T2 MPEG2

DVB-T2 MPEG4 HD

DVB-C MPEG2

DVB-C MPEG4 HD

RECEIVING CHANNELS

VHF (BAND I/III)

UHF (BAND U)

HYPERBAND

NUMBER OF PRESET CHANNELS

1000

CHANNEL INDICATOR

On Screen Display

RF AERIAL INPUT

75 Ohm (unbalanced)

OPERATING VOLTAGE

220-240V AC, 50 Hz.

AUDIO

German + Nicam Stereo

AUDIO OUTPUT POWER (W_{RMS}) (10% THD) 2 x 8

POWER CONSUMPTION (W) 85 W (max)

PANEL 16:9

TV Dimensions

DxLxH (with foot): 220 x 965 x 612

DxLxH (without foot): 77-95 x 965 x 572

Weight

10, 15 kg (with foot) / 9,30 kg (without foot)

Vesa: M6 200 x 200

Licence Notifications

Manufactured under license from Dolby Laboratories.

TRADEMARK ACKNOWLEDGMENT

 **DOLBY**
DIGITAL PLUS and the double-D symbol are trademarks of Dolby Laboratories.

“DLNA®, the DLNA Logo and DLNA CERTIFIED® are trademarks, service marks, or certification marks of the Digital Living Network Alliance.”



“HDMI, the HDMI logo and High-Definition Multimedia Interface are trademarks or registered trademarks of HDMI Licensing LLC.”



Disposal information

Instructions for waste disposal:

Packaging and packaging aids are recyclable and should principally be recycled. Packaging materials, such as foil bag, must be kept away from children. Batteries, including those which are heavy metal-free, should not be disposed of with household waste. Please dispose of used battery in an environment friendly manner. Find out about the legal regulations which apply in your area.

Information for Users in European Union Countries

The above mark is in compliance with the Waste Electrical and Electronic Equipment Directive 2002/96/EC (WEEE). The mark indicates the requirement NOT to dispose the equipment including any spent or discarded batteries as unsorted municipal waste, but use the return and collection systems available. If the batteries or accumulators included with this equipment display the chemical symbol Hg, Cd, or Pb, then it means that the battery has a heavy metal content of more than 0.0005% Mercury, or more than 0.002% Cadmium or more than, 0.004% Lead.



- Don't try to recharge batteries. Danger of explosion. Replace batteries only with the same or equivalent type.

Supported File Formats for USB Media Browser

Media	Extension	Format		Notes
		Video	Audio	
Movie	dat, mpg, mpeg	Mpeg1,2	MPEG1/2 Layer 1/2/3, AAC/HEAAC, AC3/EAC3, LPCM/ADPCM	1080P@ 30fps 50Mbit/sec
	dat, mpg, mpeg	MPEG2 ,H.264, VC1, AVS, MVC	MPEG1/2 Layer 1/2/3, AAC/HEAAC, AC3/EAC3, LPCM/ADPCM	H.264:1080Px2@25fps 1080P@ 50fps MVC: 1080P@ 24fps Other: 1080P@ 30fps' 50Mbit/sec
	.vob	MPEG2	MPEG1/2 Layer 1/2/3, AC3, LPCM	1080P@ 30fps 50Mbit/sec
	.mkv	MPEG1,2,4, XviD, H.264, VC1,WMV3, Motion JPEG	MPEG1/2 Layer 1/2/3, AAC/HEAAC, AC3/EAC3, LPCM	H.264:1080Px2@25fps 1080P@ 50fps Other:1080P@ 30fps 50Mbit/sec
	.mp4 .mov		MPEG1/2 Layer 3, AAC/HEAAC, AC3/EAC3, LPCM/ADPCM	H.264: 1080Px2@25fps 1080P@ 50fps Other: 1080P@ 30fps 50Mbit/sec
	.avi	MPEG1,2,4 Xvid H.264, VC1,WMV3, Sorenson H.263 Motion JPEG	MPEG1/2 Layer 1/2/3, AAC/HEAAC, AC3/EAC3, LPCM/ADPCM, WMA	H.264: 1080Px2@25fps 1080P@ 50fps Other: 1080P@ 30fps" 50Mbit/sec
	flv	H.264, Sorenson H.263	MPEG1/2 Layer 3, AAC/HEAAC, LPCM/ADPCM	H.264: 1080Px2@25fps 1080P@ 50fps Other: 1080P@ 30fps" 50Mbit/sec
	3gp,3g2	MPEG4, H.264		1920x1080 @ 30P 20Mbit/sec
	asf, wmv	MPEG2,4, XviD, H.264, VC1,WMV3	MPEG1/2 Layer 1/2/3, AAC/HEAAC, AC3/EAC3, LPCM, WMA	1080P@ 30fps 50Mbit/sec
Music	.mp3		MPEG1 Layer 1/2/3 (MP3)	
	.wav		LPCM	
	WMA/ASF		WMA, WMA Pro	
	.m4a/ .aac		AAC, HEAAC	
Photo	.jpg .jpeg	Baseline JPEG		MAX WxH = 14592x12288 Up to 8 MegaByte
	.png	Progressive JPEG		
	.bmp	non-interlace		
	.png	interlace		
Subtitle	sub	-	-	
	srt	-	-	

Supported DVI Resolutions

When connecting devices to your TV's connectors by using DVI converter cables (not supplied), you can refer to the following resolution information.

	56Hz	60Hz	66Hz	70Hz	72Hz	75Hz
640x400				<input checked="" type="checkbox"/>		
640x480		<input checked="" type="checkbox"/>	<input checked="" type="checkbox"/>		<input checked="" type="checkbox"/>	<input checked="" type="checkbox"/>
800x600	<input checked="" type="checkbox"/>	<input checked="" type="checkbox"/>		<input checked="" type="checkbox"/>	<input checked="" type="checkbox"/>	<input checked="" type="checkbox"/>
832x624						<input checked="" type="checkbox"/>
1024x768		<input checked="" type="checkbox"/>	<input checked="" type="checkbox"/>	<input checked="" type="checkbox"/>	<input checked="" type="checkbox"/>	<input checked="" type="checkbox"/>
1152x864		<input checked="" type="checkbox"/>		<input checked="" type="checkbox"/>		<input checked="" type="checkbox"/>
1152x870						<input checked="" type="checkbox"/>
1280x768		<input checked="" type="checkbox"/>				
1360x768		<input checked="" type="checkbox"/>				<input checked="" type="checkbox"/>
1280x960		<input checked="" type="checkbox"/>				<input checked="" type="checkbox"/>
1280x1024		<input checked="" type="checkbox"/>				<input checked="" type="checkbox"/>
1400x1050		<input checked="" type="checkbox"/>				<input checked="" type="checkbox"/>
1440x900		<input checked="" type="checkbox"/>				<input checked="" type="checkbox"/>
1600x1200		<input checked="" type="checkbox"/>				
1680x1050		<input checked="" type="checkbox"/>				
1920x1080		<input checked="" type="checkbox"/>				
1920x1200		<input checked="" type="checkbox"/>				

Appendix: Nero MediaHome Installation

To install Nero MediaHome, please proceed as follows:

Note: To use DLNA function, this software should be installed to your PC.

1. Insert the Nero MediaHome installation disc in your optical disc drive.
 - The Nero MultiInstaller screen with a button to start the installation process will open automatically.
 - If below window is not displayed automatically, double-click on the file SetupX located on the Nero MediaHome installation disc.



2. Click on the button labeled Nero MediaHome Essentials to start the installation process.
 - The Nero MediaHome installation wizard is displayed.
 - If necessary change installation language from the language selection menu before continuing.



3. Click the Next button.
 - The integrated serial is displayed.
 - Please do not change displayed serial.



4. Click the Next button.
 - The License Conditions (EULA) screen is displayed.



5. Please read the license agreement carefully and select the appropriate check box if you agree to the terms of the agreement. Installation is not possible without this agreement.
6. Click the Next button.
 - The Select Installation Type screen is displayed.

It is possible to choose between Typical, meaning standard installation, or Custom installation. User defined installation allows you to determine languages to be installed and to choose the installation path.



7. Use Typical installation and click the Next button.

- The Prerequisites screen is displayed.

The Nero MediaHome installation wizard checks the availability of required third-party software on your PC. If applications are missing they are listed and must be installed before continuing installation.



8. Click the Install button.

- As soon as all prerequisites are installed, the Install button will change to a Next button.



9. Click the Next button.

- The Ready to Start Installation Process screen is displayed, installation begins and finishes automatically. A progress bar informs you of the progress of the installation process.



10. Installation finishes.

The Help us to Enhance Nero Software screen is displayed. In order to offer a better service, Nero is collecting anonymous data to determine which features are used and what problems, if any, occur.



11. If you would like to help by participating in the anonymous collection of usage data, select the check box and click the Next button.

- The final screen of the installation wizard is displayed.

12. Click the Exit button.



13. A shortcut called Nero MediaHome 4 is now placed on your desktop

Congratulations! You successfully installed Nero MediaHome 4 on your PC.

14. Run Nero MediaHome by pressing shortcut icon.

- Click ADD icon from LOCAL FOLDERS to add the folder you want to share with the network. Select the folder that you want to share and click START SERVER.



15. You can display all media types from the library. Click Refresh icon to refresh. Click STOP SERVER icon to stop server.



Getting Started with Skype

Make voice calls and video calls with Skype on your TV. Select the Skype app from the portal section to start a conversation.

Follow the on screen instructions to see how to operate related features.



NOTE

- Connect your supported webcam directly to the USB port on your TV.
- If the camera is not working properly, switch off and unplug the TV. Connect your camera again and turn the TV on.
- As soon as the TV is turned off, Skype disconnects.
- Voice level and sound quality are affected by environmental noise.
- Call quality can change with accordance to your internet connection.
- Please visit www.skype.com to learn more information and to see the Terms of Use about Skype.
- The TV must be connected to a network for Skype connection.
- The Skype app will alert you when someone calls whilst you are watching your TV or operating the Skype application.
- A Skype camera (sold separately) is required to get the full benefit of Skype's features. If you do not already have one, you will need to purchase a camera (compatible with Vesca100) to get the full benefits of Skype.

Note : When you turn on the TV and no users have been set up for Skype, the image shown to the side will appear on screen.



Licence Notification

Skype is a trade mark of Skype or its related companies. This product/application has not been approved or endorsed by Skype, Skype Communications S.a.r.l. or any of their related companies.



No emergency calls with Skype

Skype is not a replacement for your ordinary telephone and can't be used for emergency calling. Select the Skype app from the portal section to start a conversation.

Sign In & Sign Up Now



To use the Skype application, you need a Skype account.

You can create a Skype account, using this app, in the 'Sign In & Sign Up Now' menu if you don't already have one. If you already have a Skype account, enter your name and password correctly. Select Sign In and press OK.

If you have a Skype account and you forgot your password, press the Red button to view the "reset password" screen.

After successfully logging in to your account, the contact list will be displayed on screen.



You can review your contact list on the right side of the screen. Your Skype name, mood message and your camera preview (if connected) will be displayed on the left hand side of screen.

Adding a contact



By pressing the  button select the "Search Contacts" option. Enter the full name, skype name or email address of the contact you want to find and add.

Use the remote control or virtual keyboard to enter a keyword.

Recent history

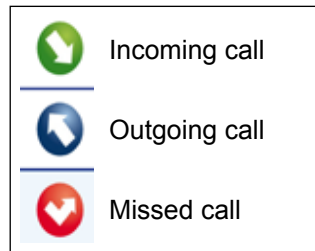

Icon meaning

Your Skype history can be seen in this section. To view recent history options, use the p+ and p- buttons. To delete a conversation, press the Red button. When you press the OK button, the contact review will be displayed. Also Profile information can be displayed in this section.

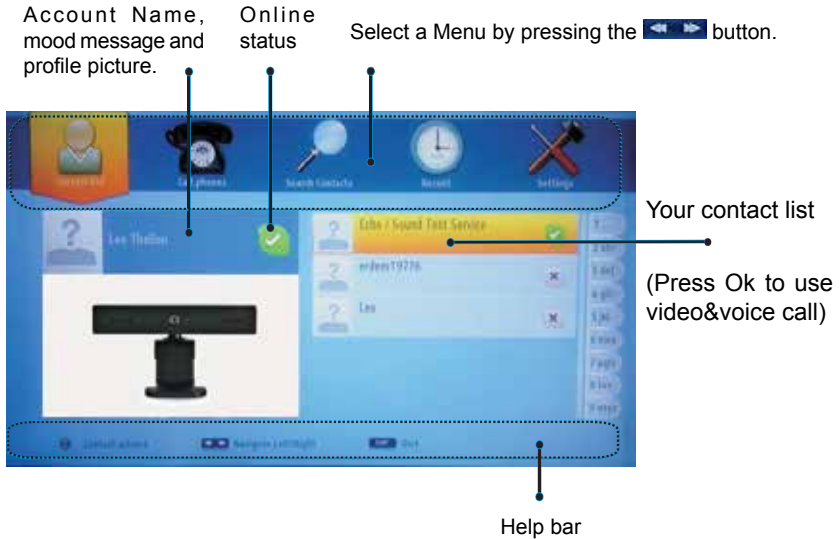

Select a person from the contact list screen and press OK. Choose an action from the list and then press OK to start the selected process. Voice and video call is ready for your use.

If available you will see the thumbnail view of yours and the other person's camera feed.



When a conversation is active, you can mute the microphone or put the other person on the line on hold. Press the Red button to end a call.



The incoming call dialog is shown when you are logged into Skype and when other users initiate a Skype call.

A small dialog box will appear in the lower right corner of the TV screen whether the user watches TV or is browsing through Skype. Use the remote control button and choose your action.

Dialing Phones



The option to call phones is available if you have Skype Credit. Please buy credit first. Afterwards, select a country then enter a phone number which you want to call.

Press the Yellow button to save an entered telephone number. Press the Green button to start a conversation.

Settings



All your Skype settings can be changed by using the Settings menu. Please use P+ and P- buttons on the remote control to move up or down. Select an option, then change the selected option by using the navigation buttons. In the about section, please find the Skype terms and conditions.

Please read this notice carefully.



Product Guarantee

This product is guaranteed against manufacturing defects for a period of



This product is guaranteed for twelve months from the date of original purchase. Any defect that arises due to faulty materials or workmanship will either be replaced, refunded or repaired free of charge where possible during this period by the dealer from whom you purchased the unit.

The guarantee is subject to the following provisions:

- The guarantee does not cover accidental damage, misuse, cabinet parts, knobs or consumable items.
- The product must be correctly installed and operated in accordance with the instructions contained in this manual.
- It must be used solely for domestic purpose.
- The guarantee will be rendered invalid if the product is re-sold or has been damaged by inexpert repair.
- Specifications are subject to change without notice.
- The manufacturer disclaims any liability for the incidental or consequential damages.
- The guarantee is in addition to, and does not diminish your statutory or legal rights.
- In the event of a problem with the product within the guarantee period call the **Customer Helpline: 0845 604 0105**.

Guarantor: Argos Ltd
489 - 499 Avebury Boulevard
Central Milton Keynes
MK9 2NW

Product fiche	
Commercial Brand: HITACHI	
Product No.	10088262
Model No.	42HXT12U
Energy efficiency class	A
Visible screen size (diagonal)	42 inches / 106 cm
On mode average power consumption	68
Annual energy consumption	99
Standby power consumption	0,5W
Off mode power consumption	0 W
Display resolution	1920 x 1080

ADDENDUM SHEET

Headphone/Lineout	<p>When you connect an external amplifier to your TV using the headphone jack, you can select this option as Lineout. If you have connected headphones to the TV, set this option as Headphone.</p> <p>Please ensure before using headphones that this menu item is set to Headphones. If it is set to Line Output, The output from the headphone socket will be set to maximum which could damage your hearing. Also please ensure before using headphones that the headphone volume is set to a low level, to prevent damage to your hearing. Please only use Headphone option for connecting external devices like <u>soundbar</u>.</p>
--------------------------	--------------------------------------------------------------------------------------------------------------------------------------------------------------------------------------------------------------------------------------------------------------------------------------------------------------------------------------------------------------------------------------------------------------------------------------------------------------------------------------------------------------------------------------------------------------------------------------------------------------------------------------------



HITACHI

Inspire the Next

Manufacturer:
Hitachi Europe Ltd.,
Whitebrook Park,
Lower Cookham Road,
Maidenhead,
Berkshire SL6 8YA
U.K.

Importer:
Argos Ltd.,
489 - 499 Avebury Boulevard,
Central Milton Keynes,
Buckinghamshire MK9 2NW
U.K.



QUICK GUIDE

42HXT12U

147/4680

Please read this quick guide fully before installing or operating because it contains important setup information and keep for future reference.

For any help concerning set up and use of your TV please call the Customer Helpline:
0845 604 0105

Lines open: 9am - 8pm Monday to Saturday and 10am - 4pm Sunday

IMPORTANT - If placing TV into cabinet or alcove, ensure there is at least a 100mm (10cm) gap to the sides, rear and top of the TV. This is to allow for adequate ventilation during operation. Please read the main Users Guide for more safety information before installation.

1

insert the batteries into your handset

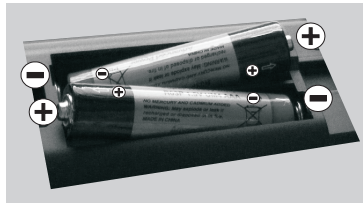

2a

either connect the aerial straight to your TV...

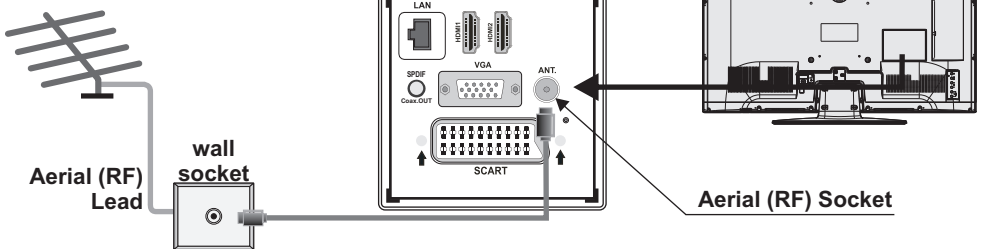

2b

...or connect the aerial through a VCR...

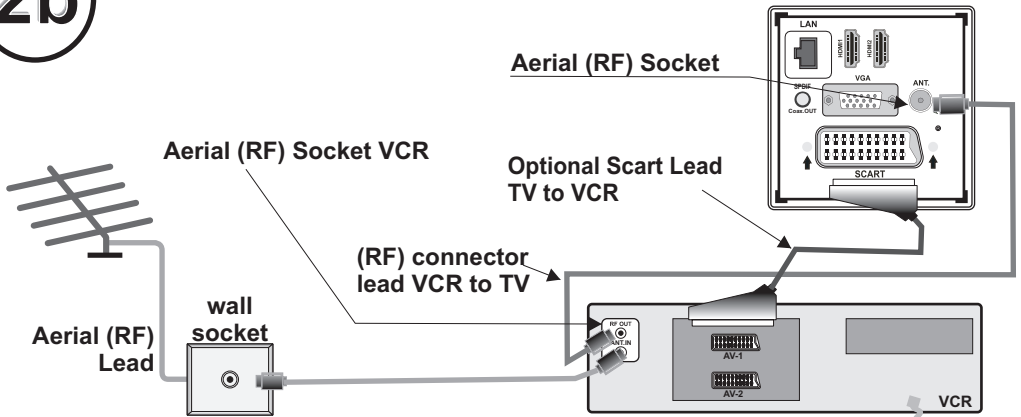

• It is recommended that a scart lead should be fitted between your TV and VCR to enhance your picture and sound quality. Scart leads are essential if you have a stereo TV and VCR and wish to obtain stereo sound from your equipment. These leads can be purchased from your Hitachi dealer or any good High Street electrical retailer.

2c

...or through a HDMI and YPbPr products (DVD-RW)

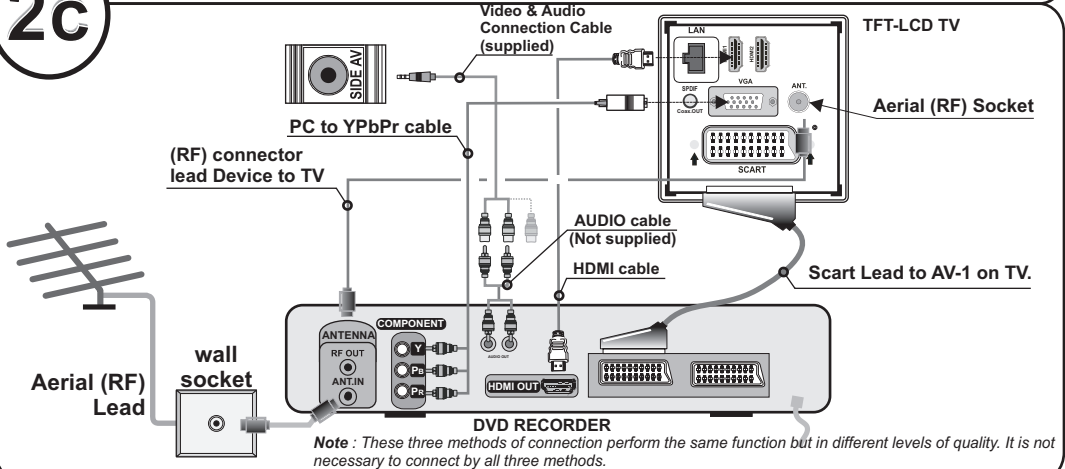

• High Definition

Your LCD Television is capable of displaying High Definition pictures from devices such as a High Definition Satellite Receiver or DVD Device. These devices must be connected via the HDMI socket or Component Socket.

2d

...or through a VCR and satellite decoder.

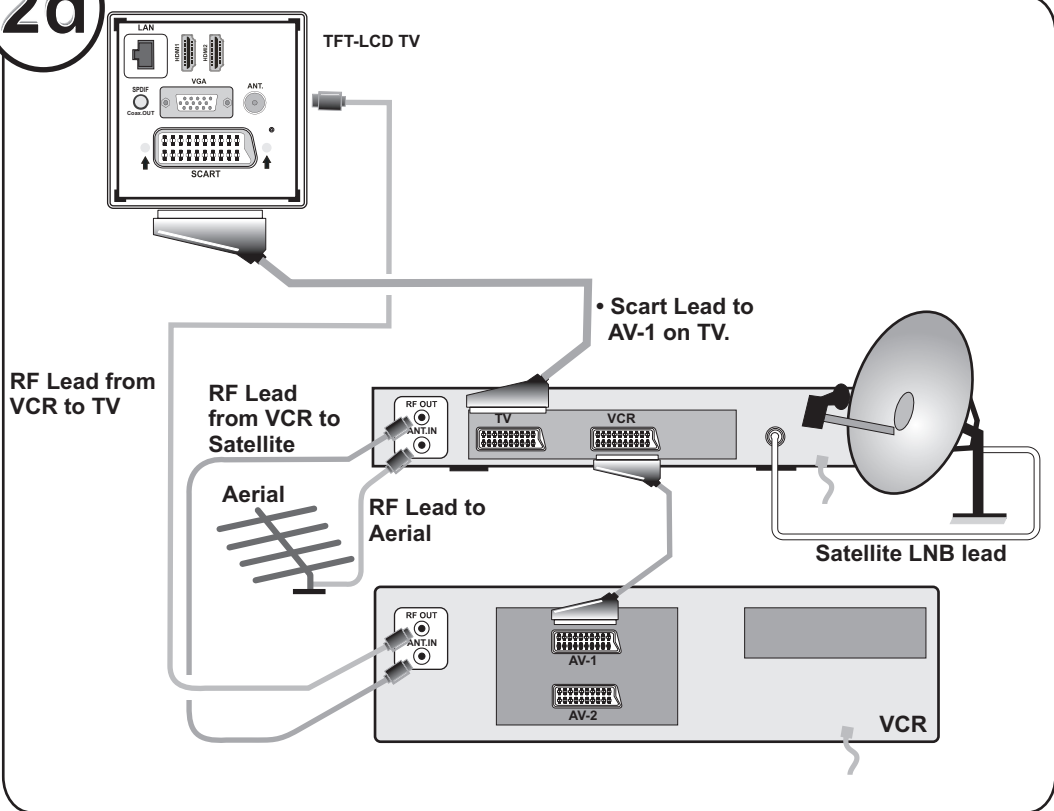

3

connect the TV plug to the mains socket

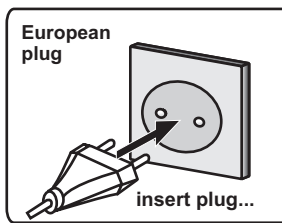
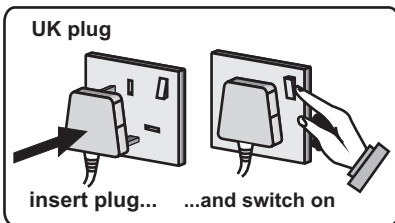

4

Press the OPERATE/STANDBY button on the remote control or press the control switch, located on the left side of the TV. The TV will then switch on.

Rear view

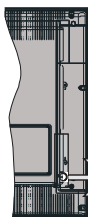

1. Up direction
2. Down direction
3. Programme/Volume/Av/Standby-on selection switch

NB: When the set is first switched on, the set will be in standby. Press or channel up/down (P-, P+) or numeric buttons (1, 2, 3, ...) on the remote control to operate.

basic functions of remote control

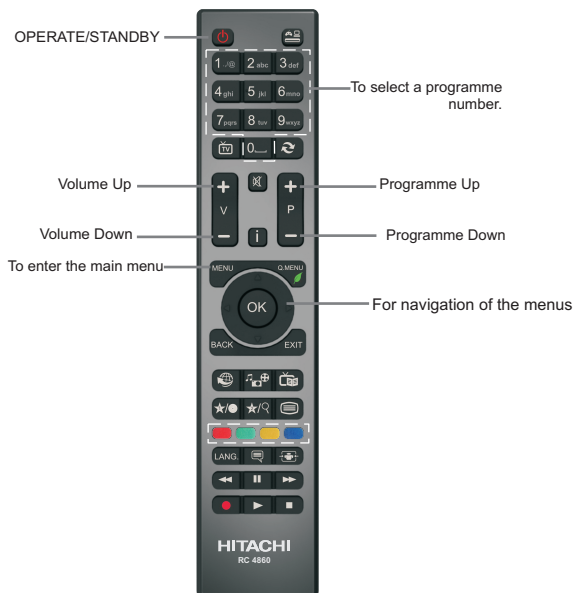

5

start A.P.S. (Auto Programming System)

1

When the TV is operated for the first time, installation wizard will guide you through the process. First, language selection screen will be displayed.

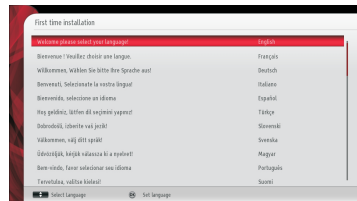

2

- Use "up" or "down" buttons to select your language and press OK button to set selected language and continue.
- After selecting the language, "First Time Installation" screen will be displayed, requiring you to set Country, Search Type, Teletext Language and Scan Encrypted options.



3

- By pressing "left" or "right" button, select the country you want to set **press "down" button to highlight Search Type option. Use Left or Right button to set the desired Search Type. Available search types are digital only, analog TV only and full.** When set, press Down button to highlight Teletext Language. Use "left" or "right" button to select desired Teletext Language.
- Press "down" button after setting Teletext Language option. Scan Encrypted will be then highlighted. You can set Scan Encrypted as Yes if you want to scan coded stations.
- Press OK button on the remote control to continue and the **next menu** will be displayed on the screen.
- You can activate Store mode option by using "left" or "right" button. If Store Mode is selected, Store mode option will be available in other settings menu and your TV's features will be illustrated on the top of the screen. A confirmation screen will be displayed after selecting the Store Mode. Select YES to proceed.
- If Home Mode is selected, Store mode will not be available after the First Time Installation. Press OK button on the remote control to Continue and the **"Do you want to start an automatic channel scan?" message** will be displayed on the screen.
- **Select "Yes" and press the OK button to continue. Digital Search Type screen will be displayed.**

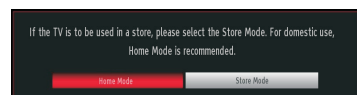

4

Please select Aerial option and press **OK** button to continue, a message asking for the starting process appears on the screen. To continue please select **YES** and press **OK**. To cancel operation, select **NO** and press **OK**. The following options will be displayed after selecting YES:

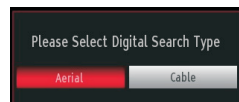

5

Note: As the Cable feature is not supported in the UK, please ensure that you select **Aerial** during the First Time Installation. If you mistakenly select **Cable**, please repeat the First Time Installation (which can be selected from the tuning menu) and select **Aerial**.



important note.

Once the TV has found all your local stations, they are then automatically assigned a programme number and name, if available from the broadcast.

